

*Thrust bearings*

---

## 1. Classification and Features

### 1.1 Thrust ball bearings

Balls are arranged between a set of washers (a shaft washer and housing washer) and the contact angle is  $90^\circ$ . Axial loads can be supported in only one direction and radial loads cannot be supported. These bearings are unsuitable for high speed operation. **Table 1** shows the standard cage models.

**Table 1** Standard cage model

Bearing series	511	512	513	514
Press cage	51120 ~51152	51220 ~51224	51320	—
Machined cage	51156 ~511750	51226 ~51292	51322 ~51340	51420

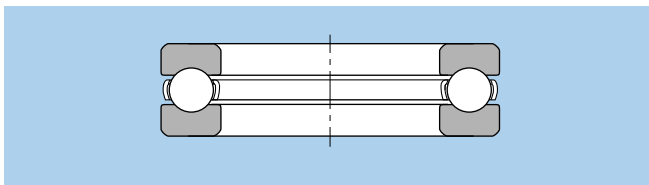

**Fig.1** Single type thrust ball bearing  
(Example of the press cage)

### 1.2 Cylindrical roller thrust bearings

These bearings use cylindrical rollers and have single row, double row, 3 row, 4 row, and also duplex types. Bearings can support only axial loads and are suitable to heavy loads. Their axial rigidity is high. Cages are the machined type.

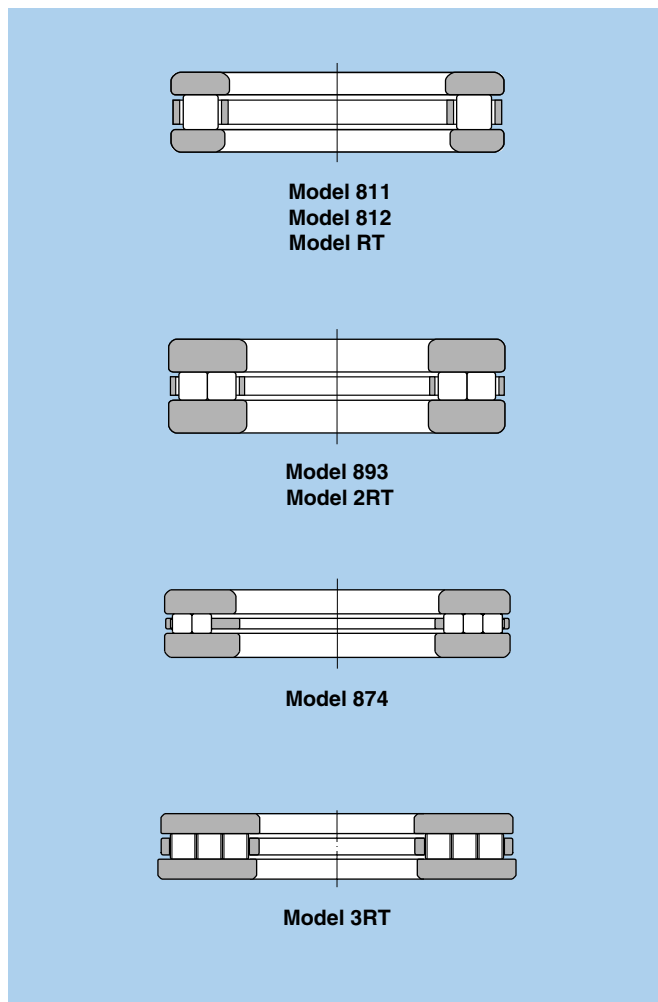

**Fig.2** Cylindrical roller thrust bearing

### 1.3 Tapered roller thrust bearings

These are thrust bearings using tapered rollers, and the single type bearings have three types of housing washers. One type is the housing raceway with a rib, the other one is without a rib, and the third bearing is the full complement roller type. Double type bearings are mainly used to support axial loads on the roll neck of rolling mill. Machined cages are used for cages.

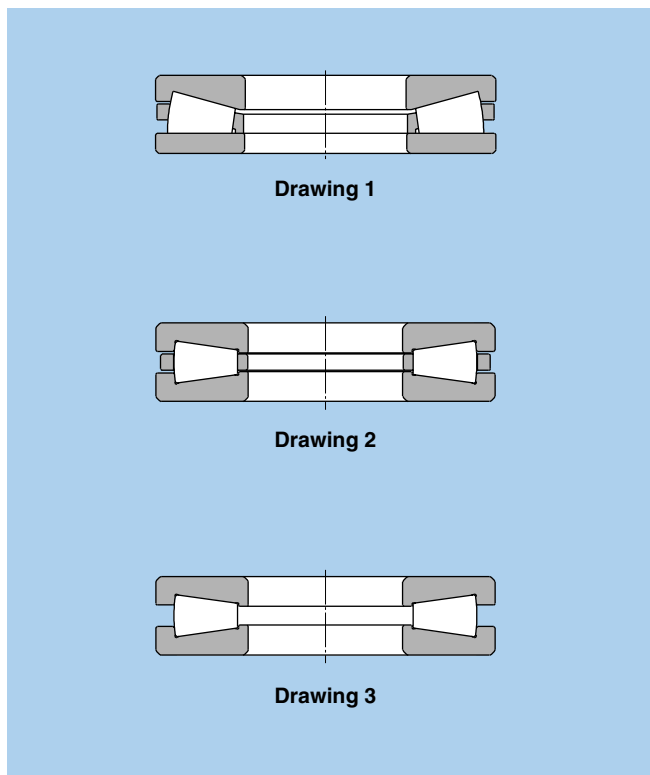

Fig.3 Tapered roller thrust bearings (Single type)

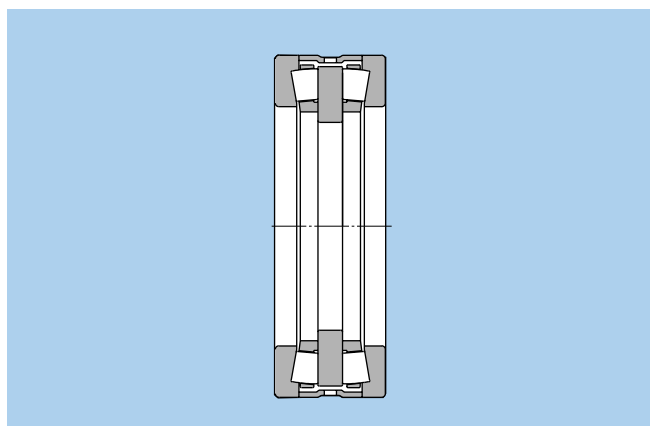

Fig.4 Tapered roller thrust bearings (Double type)

### 1.4 Self-aligning thrust roller bearings

These bearings have a self-aligning nature using barrel-shaped rollers. The allowable aligning angle varies depending on the bearing's dimension system, but it is 1° - 2° for normal loads. Cages are machined type and the guide sleeve is on the axial housing raceway. Since the load capacity for axial loads is high, these bearings can support a certain amount of radial load in the instances that axial loads are applied. However, it is necessary to use these bearing where the load conditions meet  $F_r/F_a \leq 0.55$ .

**These bearings have some spots where lubricant cannot enter such as the gap between the cage and guide sleeve. It is necessary to use oil lubrication even in low speed operation.**

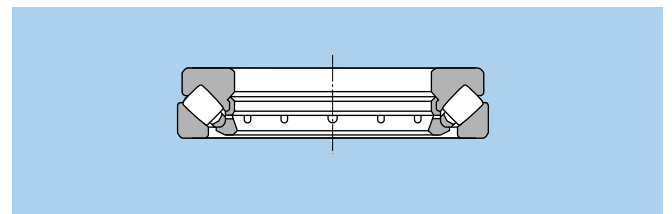

Fig.5 Self-aligning thrust roller bearing

## 2. Dimensional Accuracy / Rotation Accuracy

Thrust ball bearings	.....	Table 3.6 (Page A-18)
Cylindrical roller thrust bearings	.....	Table 3.6 (Page A-18)
Tapered roller thrust bearings	.....	Table 3.8 (Page A-19)
Self-aligning thrust roller bearings	.....	Table 3.8 (Page A-19)

## 3. Recommended Fitting

Thrust ball bearings	}	Table 4.3 (Page A-26)
Cylindrical roller thrust bearings		
Tapered roller thrust bearings		
Self-aligning thrust roller bearings		

## 4. General Operating Cautions

Thrust bearings need to load a certain amount of axial load to prevent slipping between the rolling elements and axial housing raceway. Please consult with NTN Engineering for details.



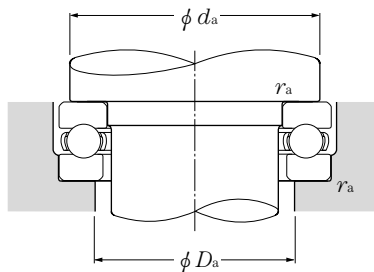
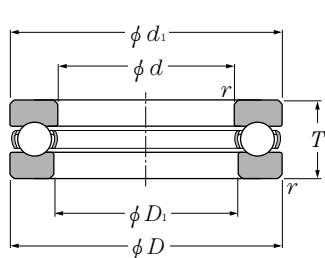

**Equivalent bearing load**  
**dynamic**  
 $P_a = F_a$   
**static**  
 $P_{oa} = F_a$

## d 100~190mm

Boundary dimensions	mm				Basic load ratings				Bearing numbers	Dimensions		Abutment and fillet dimensions			Mass
	d	D	T	r <sub>s min</sub> <sup>①</sup>	C <sub>a</sub>	C <sub>oa</sub>	C <sub>a</sub>	C <sub>oa</sub>		d <sub>1s max</sub> <sup>②</sup>	D <sub>1s min</sub> <sup>③</sup>	d <sub>a</sub> min	D <sub>a</sub> max	r <sub>as</sub> max	
100	135	25	1	85.0	268	8,700	27,300	51120	135	102	121	114	1	0.987	
	150	38	1.1	147	410	14,900	42,000	51220	150	103	130	120	1	2.29	
	170	55	1.5	237	595	24,100	60,500	51320	170	103	142	128	1.5	4.88	
	210	85	3	370	970	37,500	99,000	*51420	205	103	165	145	2.5	14.7	
110	145	25	1	87.0	288	8,900	29,400	51122	145	112	131	124	1	1.07	
	160	38	1.1	153	450	15,600	46,000	51222	160	113	140	130	1	2.46	
	190	63	2	267	705	27,300	72,000	*51322	187	113	158	142	2	7.67	
120	155	25	1	89.0	310	9,100	31,500	51124	155	122	141	134	1	1.11	
	170	39	1.1	154	470	15,700	48,000	51224	170	123	150	140	1	2.71	
	210	70	2.1	296	805	30,000	82,500	*51324	205	123	173	157	2	10.8	
130	170	30	1	104	350	10,600	36,000	51126	170	132	154	146	1	1.73	
	190	45	1.5	191	565	19,400	57,500	*51226	187	133	166	154	1.5	4.22	
	225	75	2.1	330	960	33,500	97,500	*51326	220	134	186	169	2	12.7	
140	180	31	1	107	375	10,900	38,500	*51128	178	142	164	156	1	1.90	
	200	46	1.5	193	595	19,700	60,500	*51228	197	143	176	164	1.5	4.77	
	240	80	2.1	350	1,050	35,500	107,000	*51328	235	144	199	181	2	15.3	
150	190	31	1	109	400	11,100	41,000	*51130	188	152	174	166	1	2.00	
	215	50	1.5	220	685	22,400	70,000	*51230	212	153	189	176	1.5	5.87	
	250	80	2.1	360	1,130	37,000	115,000	*51330	245	154	209	191	2	16.1	
160	200	31	1	112	425	11,400	43,500	*51132	198	162	184	176	1	2.10	
	225	51	1.5	223	720	22,800	73,000	*51232	222	163	199	186	1.5	6.32	
	270	87	3	450	1,470	45,500	150,000	*51332	265	164	225	205	2.5	20.7	
170	215	34	1.1	134	510	13,700	52,000	*51134	213	172	197	188	1	2.77	
	240	55	1.5	261	835	26,600	85,000	*51234	237	173	212	198	1.5	7.81	
	280	87	3	465	1,570	47,000	160,000	*51334	275	174	235	215	2.5	21.6	
180	225	34	1.1	135	525	13,700	54,000	*51136	222	183	207	198	1	2.92	
	250	56	1.5	266	875	27,100	89,000	*51236	247	183	222	208	1.5	8.34	
	300	95	3	490	1,700	50,000	174,000	*51336	295	184	251	229	2.5	27.5	
190	240	37	1.1	170	655	17,400	67,000	*51138	237	193	220	210	1	3.75	
	270	62	2	310	1,060	31,500	108,000	*51238	267	194	238	222	2	11.3	

① Smallest allowable dimension for chamfer dimension r. ② Maximum allowable dimension for shaft washer outer diameter d<sub>a</sub>. ③ Maximum allowable dimension for housing washer inner diameter D<sub>a</sub>. Remarks: Bearing numbers marked \* \* signify bearings where the bearing shaft washer outer diameter is smaller than the housing shaft washer outer diameter. Therefore when using these bearings, it is possible to use the housing bore as is, without providing a ground undercut on the outer diameter section of the bearing shaft washer as shown in the drawing.

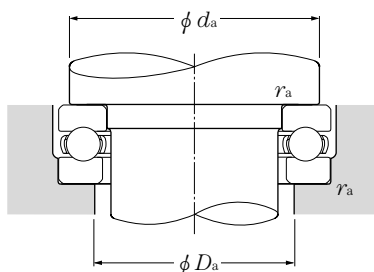
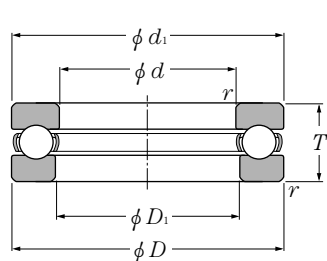

**Equivalent bearing load**  
**dynamic**  
 $P_a = F_a$   
**static**  
 $P_{oa} = F_a$

## d 190~420mm

Boundary dimensions mm	dynamic		Basic load ratings		Bearing numbers	Dimensions		Abutment and fillet dimensions			Mass kg (approx.)			
	$C_a$	$C_{oa}$	static kN	dynamic kgf		mm	mm	$d_a$ min	$D_a$ max	$r_{as}$ max				
$d$ $D$ $T$ $r_{s\ min}^{\text{①}}$	$C_a$	$C_{oa}$	$C_a$	$C_{oa}$	$d_{1s\ max}^{\text{②}}$	$D_{1s\ min}^{\text{③}}$	$d_a$ min	$D_a$ max	$r_{as}$ max					
<b>190</b>	320	105	4	545	1,950	55,500	199,000	*51338	315	195	266	244	3	35.0
<b>200</b>	250	37	1.1	172	675	17,500	69,000	*51140	247	203	230	220	1	3.92
	280	62	2	315	1,110	32,000	113,000	*51240	277	204	248	232	2	11.8
	340	110	4	595	2,220	61,000	227,000	*51340	335	205	282	258	3	41.8
<b>220</b>	270	37	1.1	177	740	18,100	75,500	*51144	267	223	250	240	1	4.27
	300	63	2	325	1,210	33,000	123,000	*51244	297	224	268	252	2	13.0
<b>240</b>	300	45	1.5	228	935	23,200	95,000	*51148	297	243	276	264	1.5	6.87
	340	78	2.1	415	1,650	42,500	168,000	*51248	335	244	299	281	2	22.4
<b>260</b>	320	45	1.5	232	990	23,600	101,000	*51152	317	263	296	284	1.5	7.38
	360	79	2.1	440	1,810	45,000	184,000	*51252	355	264	319	301	2	24.2
<b>280</b>	350	53	1.5	305	1,270	31,000	130,000	*51156	347	283	322	308	1.5	11.8
	380	80	2.1	460	1,970	47,000	201,000	*51256	375	284	339	321	2	26.1
<b>300</b>	380	62	2	355	1,560	36,000	159,000	*51160	376	304	348	332	2	17.2
	420	95	3	590	2,680	60,000	273,000	*51260	415	304	371	349	2.5	40.6
<b>320</b>	400	63	2	365	1,660	37,000	169,000	*51164	396	324	368	352	2	18.4
	440	95	3	595	2,800	61,000	285,000	*51264	435	325	392	368	2.5	44.9
<b>340</b>	420	64	2	375	1,760	38,000	179,000	*51168	416	344	388	372	2	19.7
	460	96	3	605	2,920	61,500	298,000	*51268	455	345	412	388	2.5	47.8
<b>360</b>	440	65	2	380	1,860	39,000	190,000	*51172	436	364	408	392	2	21.1
	500	110	4	720	3,650	73,500	375,000	*51272	495	365	444	416	3	69.0
<b>380</b>	460	65	2	380	1,910	39,000	195,000	*51176	456	384	428	412	2	22.3
	520	112	4	735	3,800	74,500	390,000	*51276	515	385	464	436	3	73.7
<b>400</b>	480	65	2	390	2,010	40,000	205,000	*51180	476	404	448	432	2	23.3
	540	112	4	745	3,950	76,000	405,000	*51280	535	405	484	456	3	76.9
<b>420</b>	500	65	2	395	2,110	40,500	215,000	*51184	495	424	468	452	2	24.4
	580	130	5	865	4,850	88,500	490,000	*51284	575	425	516	484	4	109

① Smallest allowable dimension for chamfer dimension  $r$ . ② Maximum allowable dimension for shaft washer outer dimension  $d_1$ . ③ Maximum allowable dimension for housing washer inner dimension  $D_1$ . Remarks: Bearing numbers marked "\*" signify bearings where the bearing shaft washer outer diameter is smaller than the housing shaft washer outer diameter. Therefore when using these bearings, it is possible to use the housing bore as is, without providing a ground undercut on the outer diameter section of the bearing shaft washer as shown in the drawing.



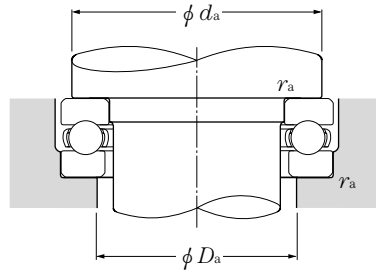
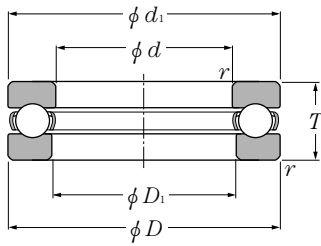

**Equivalent bearing load**  
**dynamic**  
 $P_a = F_a$   
**static**  
 $P_{0a} = F_a$

**d 440~750mm**

Boundary dimensions	Basic load ratings		Bearing numbers	Dimensions		Abutment and fillet dimensions			Mass					
	dynamic	static		mm	mm	mm	mm	mm						
mm	kN			mm		mm	mm	mm	kg					
$d$ $D$ $T$ $r_{s\ min}^{\text{①}}$	$C_a$	$C_{0a}$	$C_a$	$d_{1s\ max}^{\text{②}}$	$D_{1s\ min}^{\text{③}}$	$d_a$	$D_a$	$r_{as}$	(approx.)					
			kgf			min	max	max						
<b>440</b>	540	80	2.1	515	2,850	<b>52,500</b>	<b>291,000</b>	<b>*51188</b>	535	444	499	481	2	40.0
	600	130	5	855	4,850	<b>87,500</b>	<b>490,000</b>	<b>*51288</b>	595	445	536	504	4	113
<b>460</b>	560	80	2.1	525	3,000	<b>53,500</b>	<b>305,000</b>	<b>*51192</b>	555	464	519	501	2	41.6
	620	130	5	895	5,250	<b>91,000</b>	<b>535,000</b>	<b>*51292</b>	615	465	556	524	4	118
<b>480</b>	580	80	2.1	525	3,100	<b>54,000</b>	<b>315,000</b>	<b>*51196</b>	575	484	539	521	2	43.3
<b>500</b>	600	80	2.1	575	3,400	<b>58,500</b>	<b>345,000</b>	<b>*511/500</b>	595	504	559	541	2	45.0
<b>530</b>	640	85	3	645	4,000	<b>66,000</b>	<b>405,000</b>	<b>*511/530</b>	635	534	595	575	2.5	55.8
<b>560</b>	670	85	3	595	3,750	<b>60,500</b>	<b>385,000</b>	<b>*511/560</b>	665	564	625	605	2.5	59.4
<b>600</b>	710	85	3	645	4,200	<b>66,000</b>	<b>430,000</b>	<b>*511/600</b>	705	604	666	644	2.5	62.6
<b>630</b>	750	95	3	720	4,850	<b>73,500</b>	<b>495,000</b>	<b>*511/630</b>	745	634	702	678	2.5	82.5
<b>670</b>	800	105	4	825	5,850	<b>84,000</b>	<b>600,000</b>	<b>*511/670</b>	795	674	748	722	3	105
<b>710</b>	850	112	4	875	6,350	<b>89,000</b>	<b>650,000</b>	<b>*511/710</b>	845	714	794	766	3	129
<b>750</b>	900	120	4	1,010	7,650	<b>103,000</b>	<b>780,000</b>	<b>*511/750</b>	895	755	841	809	3	155

① Smallest allowable dimension for chamfer dimension  $r$ . ② Maximum allowable dimension for shaft washer outer dimension  $d_1$ . ③ Maximum allowable dimension for housing washer inner dimension  $D_1$ . Remarks: Bearing numbers marked \*\* signify bearings where the bearing shaft washer outer diameter is smaller than the housing shaft washer outer diameter. Therefore when using these bearings, it is possible to use the housing bore as is, without providing a ground undercut on the outer diameter section of the bearing shaft washer as shown in the drawing.





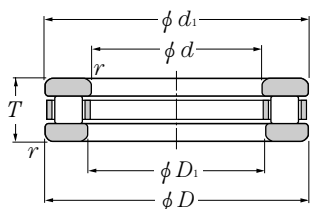

**Type 811**  
**Type 812**

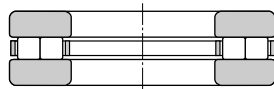

**Type 893**

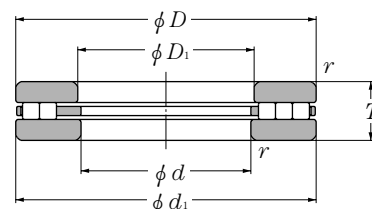

**Type 874**

**d 100~180mm**

d	Boundary dimensions			dynamic Ca	Basic load ratings		dynamic Ca	static Coa	Bearing numbers
	D	T	rs.min <sup>①</sup>		static kN	static kgf			
100	135	25	1	158	555	16,100	57,000	81120L1	
	150	38	1.1	243	795	24,800	81,000	81220L1	
	170	42	1.5	335	1,370	34,500	140,000	89320L1	
	210	50	3	580	2,650	59,000	271,000	87420L1	
110	145	25	1	165	605	16,800	61,500	81122L1	
	160	38	1.1	259	885	26,400	90,000	81222L1	
	190	48	2	430	1,770	44,000	180,000	89322L1	
	230	54	3	725	3,150	74,000	325,000	87422L1	
120	155	25	1	172	655	17,500	66,500	81124L1	
	170	39	1.1	264	930	26,900	94,500	81224L1	
	210	54	2.1	555	2,300	56,500	235,000	89324L1	
	250	58	4	830	3,900	84,500	395,000	87424L1	
130	170	30	1	197	755	20,100	77,000	81126L1	
	190	45	1.5	360	1,210	36,500	123,000	81226L1	
	225	58	2.1	615	2,600	63,000	265,000	89326L1	
	270	63	4	895	4,250	91,500	435,000	87426L1	
140	180	31	1	206	815	21,000	83,000	81128L1	
	200	46	1.5	370	1,280	38,000	130,000	81228L1	
	240	60	2.1	695	2,980	71,000	305,000	89328L1	
	280	63	4	940	4,600	96,000	470,000	87428L1	
150	190	31	1	214	870	21,800	89,000	81130L1	
	215	50	1.5	455	1,580	46,000	161,000	81230L1	
	250	60	2.1	710	3,130	72,500	320,000	89330L1	
160	200	31	1	221	930	22,600	95,000	81132L1	
	225	51	1.5	518	1,930	53,000	197,000	81232L1	
	270	67	3	835	3,690	85,500	375,000	89332L1	

① Smallest allowable dimension for chamfer dimension r.

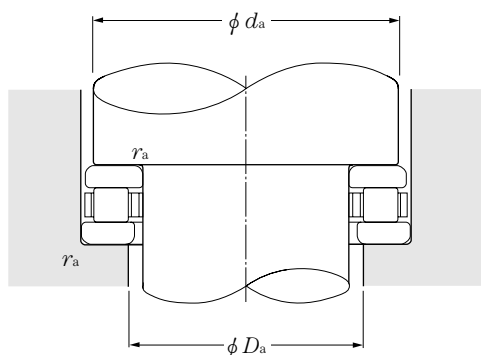

Dimensions		Abutment and fillet dimensions			Mass
mm		mm			kg
$d_1$	$D_1$	$d_a$ min	$D_a$ max	$r_{as}$ max	(approx.)
135	102	128	106	1	1.220
150	103	139	109	1	2.730
170	103	163	110	1.5	4.500
210	103	203	112	3	9.500
<hr/>					
145	112	138	116	1	1.330
160	113	149	119	1	2.980
190	113	183	122	2	6.350
230	113	221	118	3	11.850
<hr/>					
155	122	148	126	1	1.410
170	123	159	129	1	3.280
210	123	201	132	2	9.000
250	123	241	132	4	15.690
<hr/>					
170	132	162	137	1	2.020
187	133	178	140	1.5	5.050
225	134	216	143	2	10.370
270	134	262	147	4	19.750
<hr/>					
178	142	172	147	1	2.250
197	143	188	150	1.5	5.460
240	144	231	154	2	12.600
280	144	273	158	4	20.940
<hr/>					
188	152	182	157	1	2.410
212	153	202	160	1.5	6.870
250	154	242	165	2	13.320
<hr/>					
198	162	192	167	1	2.500
222	163	216	174	1.5	6.910
270	164	262	177	3	17.250



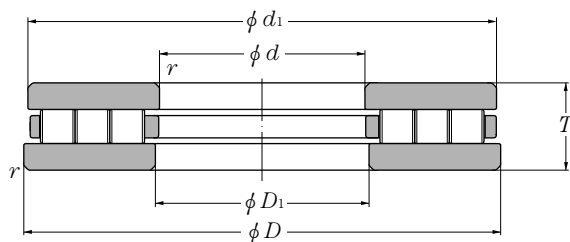

**d 180~304.8mm**

d	Boundary dimensions			dynamic Ca	Basic load ratings		dynamic Ca	static C <sub>oa</sub>	Bearing numbers
	D	T	r <sub>s.min</sub> <sup>①</sup>		static C <sub>oa</sub>	dynamic C <sub>a</sub>			
180	220	22	1.0	160	715	16,300	72,500	RT3615 2RT3618	
	300	73	3.0	1,090	4,900	111,000	495,000		
190	270	62	2.5	745	2,780	76,000	284,000	RT3812 2RT3811	
	330	70	4.0	1,260	5,900	129,000	600,000		
200	340	75	5.0	1,320	6,150	134,000	630,000	2RT4028 2RT4030 2RT4024 2RT4032	
	340	85	5.0	1,260	4,950	128,000	505,000		
	370	85	4.0	1,760	7,400	179,000	755,000		
	400	122	5.0	2,230	8,250	227,000	840,000		
203.2	406.4	76.2	6.0	1,530	7,850	156,000	800,000	3RT4101	
210	250	25	1.5	133	635	13,600	64,500	RT4206	
220	270	25	1.0	217	1,060	22,100	109,000	RT4411 2RT4416 2RT4425 3RT4406	
	360	85	outer 4.0 inner 2.0	1,380	5,950	140,000	610,000		
	400	80	2.0	1,720	7,750	175,000	790,000		
	430	88	5.0	1,880	9,100	191,000	930,000		
222.25	520.7	114.3	4.0	5,100	20,500	520,000	2,090,000	2RT4426 2RT4427	
	520.7	165	4.0	5,100	20,500	520,000	2,090,000		
240	320	45	2.0	670	3,350	6,800	340,000	2RT4814 2RT4803	
	425	90	2.0	1,820	8,850	186,000	905,000		
254	457.2	95.25	6.0	2,360	12,100	240,000	1,240,000	3RT5107	
260	340	55	1.5	790	3,350	80,500	340,000	RT5211	
270	540	105	5.0	3,100	15,800	315,000	1,610,000	3RT5404	
280	380	55	2.5	645	2,900	65,500	296,000	RT5606 2RT5610	
	520	109	4.0	2,900	13,200	296,000	1,340,000		
290	350	35	1.5	345	1,760	35,000	180,000	RT5805	
304.8	457.2	95.25	6.0	1,770	8,250	181,000	840,000	2RT6108	

① RT: single row, 2RT: double row, 3RT: triple row  
 ② Smallest allowable dimension for chamfer dimension r.

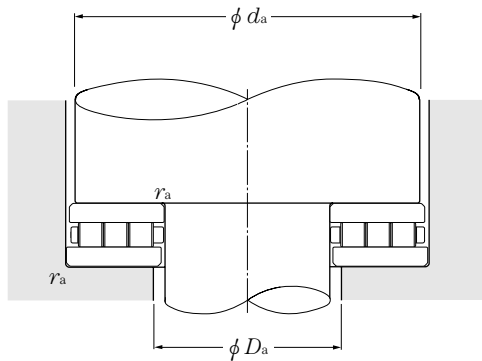

Dimensions mm		Abutment and fillet dimensions mm			Mass kg (approx.)
$d_1$	$D_1$	$d_a$ min	$D_a$ max	$r_{as}$ max	
219	181	213	187	1	1.77
300	184	298	188	2.5	23.3
270	195	264	196	2	11.9
329.5	190.5	327	200	3	27.9
340	201	335	204	4	31.4
340	202	332	212	4	35.0
370	200.5	362	210	3	44.3
396	204	388	216	4	80.3
404.038	205.562	389	214	5	52.1
250	210	243	217	1.5	2.51
269	221	262	234	1	3.16
359	221	349	233	outer 3 inner 2	38.1
399	221	382	244	2	48.5
430	222	418	230	4	64.6
514.7	228	511	231	3	135
514.7	228	511	231	3	203
316	244	313	247	2	10.4
425	241	408	254	2	61.6
456	256	453	261	5	76.0
339.5	260.4	328	270	1.5	13.9
530	277	530	282	4	125
375	285	358	302	2	18.0
520	280	501	309	3	113
350	290	338	302	1.5	6.92
454.8	307.2	450	318	5	60.0



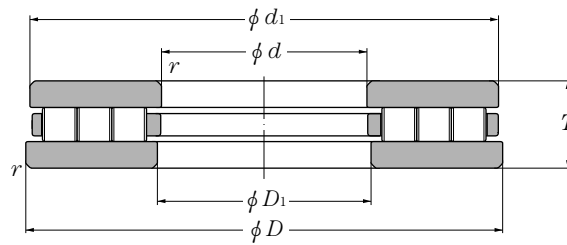

**d 320~560mm**

d	Boundary dimensions			Basic load ratings				Bearing numbers
	D	T	$r_{s.min}^{①}$	dynamic kN	static kN	dynamic kgf	static kgf	
320	380	30	1.5	274	1,510	28,000	154,000	RT6405 RT6406 3RT6404
	440	95	3.0	1,670	7,100	171,000	725,000	
	600	115	5.0	4,100	20,600	415,000	2,110,000	
360	610	120	5.0	3,800	18,200	390,000	1,860,000	2RT7205
380	520	112	4.0	1,900	7,850	194,000	800,000	RT7607
400	500	63	4.0	1,300	6,400	132,000	650,000	RT8009 RT8005
	540	85	4.0	1,970	10,100	200,000	1,030,000	
425	650	110	4.0	3,500	19,200	360,000	1,960,000	2RT8502
440	540	45	2.5	755	5,300	77,000	540,000	2RT8807
540	705	100	5.0	2,240	11,700	228,000	1,200,000	RT10802
560	660	50	3.0	1,040	7,850	106,000	800,000	2RT11207 RT11204 2RT11208
	670	85	3.0	1,850	10,200	188,000	1,040,000	
	820	113	5.0	4,350	26,000	445,000	2,650,000	

① RT: single row, 2RT: double row, 3RT: triple row  
 ② Smallest allowable dimension for chamfer dimension r.

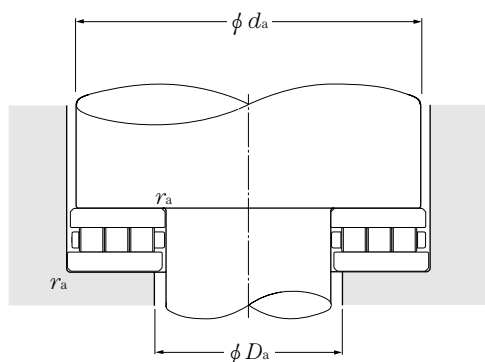

Dimensions		Abutment and fillet dimensions			Mass
mm		mm			kg
$d_1$	$D_1$	$d_a$ min	$D_a$ max	$r_{as}$ max	(approx.)
379	321	368	336	1.5	6.64
435	325	428	334	2.5	44.0
600	321	584	336	4	162
605	365	598	378	4	157
515	385	500	404	3	73.8
495	405	488	412	3	27.9
540	403	526	414	3	59.2
650	430	635	443	3	145
539	441	532	460	2	24.2
695	565	682	582	4	99.5
659	561	653	571	2.5	32.9
660	570	657	575	2.5	58.1
810	570	790	590	4	210



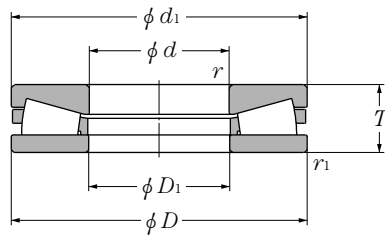

Drawing A



Drawing B

**d 101.600~254.000mm**

d	Boundary dimensions				dynamic kN	Basic load ratings			Bearing numbers
	D	T	$r_{s\ min}^{\bullet}$	$r_{1s\ min}^{\bullet}$		static	dynamic	static	
	mm	mm	mm	mm	C <sub>a</sub>	C <sub>oa</sub>	C <sub>a</sub>	C <sub>oa</sub>	
101.600	215.900	46.038	3.3	3.3	700	2,730	71,000	279,000	*CRT2010
	215.900	46.038	1.5	1.5	805	2,920	82,000	297,000	*CRT2014
107.950	228.600	69.850	2	5.6	1,070	3,100	109,000	320,000	*CRT2223
114.300	250.825	53.975	4.06	4.06	995	3,750	102,000	380,000	*CRT2301
127.000	266.700	58.738	4	4	1,130	4,650	115,000	475,000	*CRT2503
130	225	55	2.1	2.1	640	2,590	65,500	264,000	CRT2615
145	190	31	1	1	216	815	22,000	83,000	CRT2906
152.400	317.500	69.850	6.4	6.4	1,520	6,250	155,000	640,000	*CRT3018
168.275	304.800	69.850	6.4	6.4	1,250	4,950	127,000	505,000	*CRT3407
	304.800	69.850	6.4	6.4	1,350	5,100	138,000	520,000	*CRT3409
170	320	100	6	6	1,620	6,400	166,000	650,000	CRT3410
174.625	358.775	82.550	6.4	6.4	1,720	7,050	175,000	720,000	*CRT3503
177.800	368.300	82.550	8	8	2,190	8,900	223,000	910,000	*CRT3617
203.200	419.100	92.075	9.7	9.7	2,400	10,200	244,000	1,040,000	*CRT4108
	419.100	92.075	9.7	9.7	2,490	10,600	254,000	1,090,000	*CRT4112
	419.100	120.650	9.7	9.7	2,240	9,450	229,000	965,000	*CRT4105
220	370	90	4	4	1,690	7,250	172,000	740,000	CRT4405
227	325	50	2	2	610	2,720	62,000	277,000	CRT4502
228.600	482.600	104.775	11.2	11.2	3,450	15,600	350,000	1,590,000	*CRT4604
	482.600	104.775	11.2	11.2	3,250	14,300	330,000	1,460,000	*CRT4605
234.950	546.100	127.000	16	16	5,700	27,900	580,000	2,850,000	*CRT4707V
254.000	539.750	117.475	11.2	11.2	3,850	17,100	395,000	1,740,000	*CRT5103

① Minimal allowable dimension for chamfer dimension  $r$  or  $r_1$ .  
 Remarks: 1. Bearing numbers marked "\*" designate inch system bearings.  
 B-240

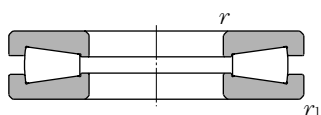

**Drawing C**

Drawing no.	Dimensions		Mass kg (approx.)
	mm		
	$D_1$	$d_1$	
B	101.6	215.9	9.06
A	102.591	215.138	8.23
B	107.95	228.6	14.0
B	114.3	250.825	13.9
B	128.6	265.1	17.7
A	130.3	225	9.14
B	147	188	2.30
B	152.4	317.5	28.5
B	168.275	304.8	24.6
A	168.275	302.5	22.2
A	170.5	320	39.4
B	174.625	358.775	39.9
B	177.8	368.3	45.0
A	203.2	416.7	60.9
B	203.2	419.1	64.9
B	203.2	419.1	79.8
A	221	369	39.2
A	227	325	13.3
B	230.6	480.6	101
A	230.6	480.6	93.2
C	234.95	546.1	160
A	254	539.75	140





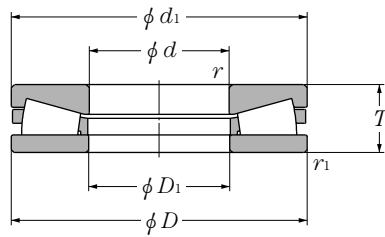

Drawing A



Drawing B

**d 260~920mm**

d	Boundary dimensions				dynamic kN	Basic load ratings			Bearing numbers
	D	T	$r_{s \min}$ ①	$r_{1s \min}$ ①		static	dynamic	static	
	mm	mm	mm	mm	C <sub>a</sub>	C <sub>oa</sub>	C <sub>a</sub>	C <sub>oa</sub>	
260	360	60	2.1	2.1	890	3,950	91,000	400,000	CRT5207
279.400	603.250	136.525	11.2	11.2	5,100	23,300	520,000	2,380,000	*CRT5613
290	395	80	3	3	1,330	5,150	136,000	525,000	CRT5804
320	580	155	7.5	7.5	4,800	18,900	490,000	1,920,000	CRT6408 CRT6401
	710	235	7.5	7.5	8,600	31,000	880,000	3,200,000	
340	460	96	3	3	1,640	7,300	167,000	745,000	CRT6803
350	460	85	3	3	1,390	5,850	142,000	600,000	CRT7012
360	600	120	6.9	5.5	3,800	17,500	390,000	1,780,000	CRT7207
406.400	711.200	146.050	9.7	9.7	6,100	30,500	620,000	3,150,000	*CRT8101
406.4	711.2	166.5	5	5	8,250	33,500	840,000	3,400,000	CRT8104
450	570	100	4	4	1,560	7,750	159,000	790,000	CRT9002 CRT9003
	750	145	8	8	6,350	31,500	645,000	3,200,000	
508.000	990.600	196.850	12.7	12.7	12,100	62,500	1,230,000	6,400,000	*CRT10202
600	745	105	5	5	2,530	13,600	258,000	1,390,000	CRT12002
920	1,120	150	7.5	7.5	5,500	32,500	560,000	3,350,000	CRT18401

① Minimal allowable dimension for chamfer dimension  $r$  or  $r_1$ .

Remarks: 1. Bearing numbers marked "\*" designate inch system bearings.

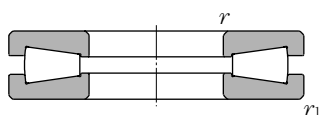

**Drawing C**

Drawing no.	Dimensions		Mass
	mm		
	$D_1$	$d_1$	(approx.)
A	260.3	360	18.3
B	279.4	603.25	205
A	291	395	27.8
B	320.5	580	179
A	320	708	465
A	340	460	49.9
A	351	450	37.3
A	366	620	136
B	406.4	711.2	245
A	409	709	301
A	452	570	60.3
B	450.5	750	257
B	508	990.6	701
A	600.5	745	101
A	922	1,118	295



# ● Tapered Roller Thrust Bearings (Double Direction Type)

NTN

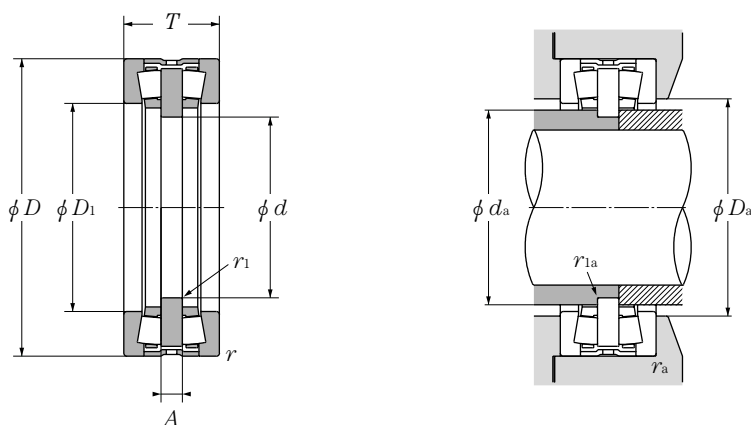

d 170~550mm

d	Boundary dimensions				Basic load ratings		Bearing numbers	Abutment and fillet dimensions					Mass kg (approx.)	
	mm				dynamic kN	static kgf		mm						
	D	T	$r_{s\min}$ <sup>①</sup>	$r_{1s\min}$ <sup>①</sup>	$C_a$	$C_a$		$D_1$	A	$d_a$	$D_a$	$r_a$	$r_{1a}$	
170	240	84	2.5	1	365	37,000	CRTD3401	184	20	179	190	2	1	12
180	280	90	2	1	645	65,500	CRTD3618	196	20	189	202	2	1	20
200	560	138	3	4	1,630	166,000	CRTD4013	430	40	413	438	2.5	3	105
212	300	96	2	1	435	44,000	CRTD4203	236	22	228	242	2	1	19.5
220	340	130	2	1.5	860	88,000	CRTD4401	250	39	242	256	2	1.5	42.1
240	320	96	2	0.6	405	41,500	CRTD4802	256	22	246	262	2	1	21
	380	105	1.5	1.5	840	85,500	CRTD4803	270	27	267	274	1.5	1.5	41.5
250	360	96	1.5	0.6	635	64,500	CRTD5007	285	24	274	289	1.5	0.6	28
	380	100	2	1	905	92,000	CRTD5005	275	22	266	281	2	1	40
260	360	92	2	1	580	59,500	CRTD5216	285	20	272	291	2	1	26
	400	120	3	1.5	920	93,500	CRTD5217	290	25	276	298	2.5	1.5	51.5
300	420	100	2	2	880	89,500	CRTD6001	330	23	320	335	2	2	38
305	530	200	5	1.5	2,500	255,000	CRTD6104	345	56	332	357	4	1.5	165
320	440	108	3	2	980	100,000	CRTD6406	355	20	344	363	2.5	2	43
	470	130	3	2	1,390	142,000	CRTD6404	350	30	335	358	2.5	2	73
350	490	130	3	1.1	1,150	118,000	CRTD7012	390	30	375	398	2.5	1.5	72
380	560	130	3	2	1,630	166,000	CRTD7612	430	32	410	438	2.5	2	102
410	560	160	5	2	1,660	169,000	CRTD8201	440	40	428	446	4	2	111
420	620	170	3	1.1	2,190	223,000	CRTD8403	465	35	448	473	2.5	1	155
440	645	167	5	2	2,070	211,000	CRTD8802	500	50	470	495	2	2	176
470	720	200	4	4	3,450	355,000	CRTD9408	535	40	507	545	3	3	261
550	760	230	4	2	2,910	296,000	CRTD11002	610	50	577	622	4	2	296

① Minimum allowable dimension for chamfer dimension  $r$  or  $r_1$ .

Remarks: 1.  $C_a$  does not mean allowable load ratings. Please contact NTN Engineering.  
B-244



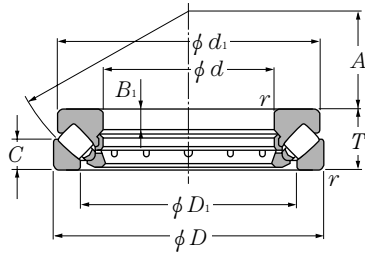

**d 100~200mm**

d	Boundary dimensions			dynamic Ca	Basic load ratings		static C <sub>oa</sub>	dynamic Ca	static C <sub>oa</sub>	Bearing numbers	Dimensions				
	D	T	r <sub>s min</sub> <sup>①</sup>		static C <sub>oa</sub>	dynamic kgf					D <sub>1</sub>	d <sub>1</sub>	B <sub>1</sub>	C	A
100	170	42	1.5	345	1,160	35,500	118,000	29320 29420	129	163	14	20.8	58		
	210	67	3	685	2,130	69,500	217,000		146	200	24	32	62		
110	190	48	2	445	1,500	45,000	152,000	29322 29422	143	182	16	23	64		
	230	73	3	845	2,620	86,500	267,000		162	220	26	35	69		
120	210	54	2.1	535	1,770	54,500	181,000	29324 29424	159	200	18	26	70		
	250	78	4	975	3,050	99,000	310,000		174	236	29	37	74		
130	225	58	2.1	615	2,100	62,500	215,000	29326 29426	171	215	19	28	76		
	270	85	4	1,080	3,550	110,000	360,000		189	255	31	41	81		
140	240	60	2.1	685	2,360	70,000	241,000	29328 29428	183	230	20	29	82		
	280	85	4	1,110	3,750	114,000	385,000		199	268	31	41	86		
150	215	39	1.5	340	1,340	34,500	136,000	29230 29330 29430	178	208	14	19	82		
	250	60	2.1	675	2,390	68,500	243,000		194	240	20	29	87		
	300	90	4	1,280	4,350	131,000	445,000		214	285	32	44	92		
160	225	39	1.5	360	1,460	36,500	149,000	29232 29332 29432	188	219	14	19	86		
	270	67	3	820	2,860	84,000	292,000		208	260	24	32	92		
	320	95	5	1,500	5,150	153,000	525,000		229	306	34	45	99		
170	240	42	1.5	425	1,770	43,500	180,000	29234 29334 29434	198	233	15	20	92		
	280	67	3	855	3,050	87,000	310,000		216	270	23	32	96		
	340	103	5	1,660	5,750	169,000	590,000		243	324	37	50	104		
180	250	42	1.5	450	1,920	45,500	196,000	29236 29336 29436	208	243	15	20	97		
	300	73	3	995	3,600	102,000	365,000		232	290	25	35	103		
	360	109	5	1,840	6,200	188,000	635,000		255	342	39	52	110		
190	270	48	2	530	2,230	54,000	227,000	29238 29338 29438	223	262	15	24	104		
	320	78	4	1,150	4,250	117,000	430,000		246	308	27	38	110		
	380	115	5	2,010	6,800	205,000	695,000		271	360	41	55	117		
200	280	48	2	535	2,300	54,500	234,000	29240 29340 29440	236	271	15	24	108		
	340	85	4	1,280	4,600	131,000	470,000		261	325	29	41	116		
	400	122	5	2,230	7,650	228,000	780,000		286	380	43	59	122		

① Minimum allowable dimension for chamfer dimension r or r<sub>s</sub>.

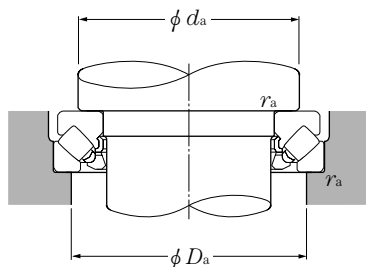

**Equivalent bearing load**

**dynamic**

$$P_a = F_a + 1.2F_r$$

**static**

$$P_{0a} = F_a + 2.7F_r$$

when  $\frac{F_r}{F_a} \leq 0.55$

Abutment and fillet dimensions			Mass
$d_a$	$D_a$	$r_{as}$	kg
min	max	max	(approx.)
130	150	1.5	3.94
150	175	2.5	11.5
145	165	2	5.78
165	190	2.5	15
160	180	2	7.92
180	205	3	18.6
170	195	2	9.76
195	225	3	23.7
185	205	2	11.4
205	235	3	25.2
179	196	1.5	4.56
195	215	2	12
220	250	3	30.5
189	206	1.5	4.88
210	235	2.5	15.9
230	265	4	37
201	218	1.5	6.02
220	245	2.5	16.6
245	285	4	45
211	228	1.5	6.27
235	260	2.5	21.2
260	300	4	52.9
225	245	2	8.8
250	275	3	26
275	320	4	62
235	255	2	9.14
265	295	3	31.9
290	335	4	73.3



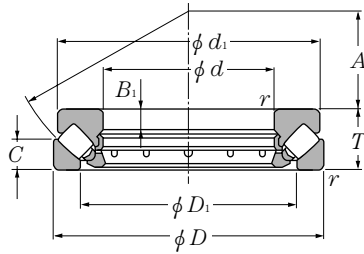

**d 220~400mm**

d	Boundary dimensions			dynamic	Basic load ratings			Bearing numbers	Dimensions				
	mm				dynamic	static	dynamic		static	mm			
	D	T	r <sub>s min</sub> <sup>①</sup>	C <sub>a</sub>	C <sub>oa</sub>	C <sub>a</sub>	C <sub>oa</sub>		D <sub>1</sub>	d <sub>1</sub>	B <sub>1</sub>	C	A
220	300	48	2	555	2,480	56,500	253,000	29244	254	292	15	24	117
	360	85	4	1,390	5,200	141,000	530,000	29344	280	345	29	41	125
	420	122	6	2,300	8,100	235,000	825,000	29444	308	400	43	58	132
240	340	60	2.1	825	3,600	84,000	365,000	29248	283	330	19	30	130
	380	85	4	1,380	5,250	140,000	535,000	29348	300	365	29	41	135
	440	122	6	2,400	8,700	245,000	885,000	29448	326	420	43	59	142
260	360	60	2.1	870	3,950	88,500	400,000	29252	302	350	19	30	139
	420	95	5	1,710	6,800	175,000	695,000	29352	329	405	32	45	148
	480	132	6	2,740	10,000	279,000	1,020,000	29452	357	460	48	64	154
280	380	60	2.1	875	4,050	89,000	415,000	29256	323	370	19	30	150
	440	95	5	1,800	7,250	184,000	740,000	29356	348	423	32	46	158
	520	145	6	3,350	12,400	340,000	1,270,000	29456	387	495	52	68	166
300	420	73	3	1,190	5,350	121,000	545,000	29260	353	405	21	38	162
	480	109	5	2,140	8,250	218,000	840,000	29360	379	460	37	50	168
	540	145	6	3,450	13,200	350,000	1,340,000	29460	402	515	52	70	175
320	440	73	3	1,260	5,800	128,000	595,000	29264	372	430	21	38	172
	500	109	5	2,220	8,800	226,000	895,000	29364	399	482	37	53	180
	580	155	7.5	3,700	14,200	375,000	1,440,000	29464	435	555	55	75	191
340	460	73	3	1,240	5,800	126,000	590,000	29268	395	445	21	37	183
	540	122	5	2,650	10,700	270,000	1,090,000	29368	428	520	41	59	192
	620	170	7.5	4,400	17,500	445,000	1,790,000	29468	462	590	61	82	201
360	500	85	4	1,510	7,050	154,000	720,000	29272	423	485	25	44	194
	560	122	5	2,710	11,100	276,000	1,130,000	29372	448	540	41	59	202
	640	170	7.5	4,500	18,500	460,000	1,890,000	29472	480	610	61	82	210
380	520	85	4	1,590	7,650	162,000	780,000	29276	441	505	27	42	202
	600	132	6	3,200	13,300	325,000	1,360,000	29376	477	580	44	63	216
	670	175	7.5	4,900	19,700	500,000	2,010,000	29476	504	640	63	85	230
400	540	85	4	1,620	7,950	165,000	810,000	29280	460	526	27	42	212
	620	132	6	3,400	14,500	345,000	1,480,000	29380	494	596	44	64	225
	710	185	7.5	5,450	22,100	555,000	2,250,000	29480	534	680	67	89	236

① Smallest allowable dimension for chamfer dimension r.

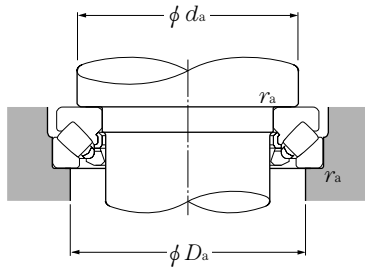

**Equivalent bearing load**

**dynamic**

$$P_a = F_a + 1.2F_r$$

**static**

$$P_{0a} = F_a + 2.7F_r$$

when  $\frac{F_r}{F_a} \leq 0.55$

Abutment and fillet dimensions			Mass
$d_a$	$D_a$	$r_{as}$	kg
min	max	max	(approx.)
260	275	2	9.94
285	315	3	34.5
310	355	5	77.8
<hr/>			
285	305	2	17.5
300	330	3	36.6
330	375	5	82.6
<hr/>			
305	325	2	18.6
330	365	4	52
360	405	5	108
<hr/>			
325	345	2	19.8
350	390	4	54.6
390	440	5	140
<hr/>			
355	380	2.5	30.9
380	420	4	75.8
410	460	5	147
<hr/>			
375	400	2.5	33.5
400	440	4	79.9
435	495	6	181
<hr/>			
395	420	2.5	34.4
430	470	4	107
465	530	6	230
<hr/>			
420	455	3	50.5
450	495	4	112
485	550	6	240
<hr/>			
440	475	3	53.4
480	525	5	143
510	575	6	267
<hr/>			
460	490	3	55.8
500	550	5	148
540	610	6	321





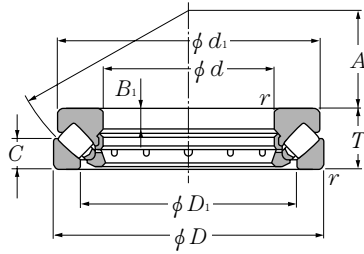

**d 420~800mm**

d	Boundary dimensions			dynamic Ca	Basic load ratings			Bearing numbers	Dimensions				
	D	T	rs min <sup>①</sup>		static kN	dynamic kN	static kgf		D1	d1	B1	C	A
420	580	95	5	2,100	10,400	214,000	1,060,000	29284	489	564	30	46	225
	650	140	6	3,600	15,500	365,000	1,580,000	29384	520	626	48	68	235
	730	185	7.5	5,500	22,800	560,000	2,330,000	29484	556	700	67	89	244
440	600	95	5	2,150	10,900	219,000	1,110,000	29288	508	585	30	49	235
	680	145	6	3,800	16,400	385,000	1,680,000	29388	548	655	49	70	245
	780	206	9.5	6,400	26,200	650,000	2,670,000	29488	588	745	74	100	260
460	620	95	5	2,150	11,000	219,000	1,120,000	29292	530	605	30	46	245
	710	150	6	4,200	18,500	430,000	1,880,000	29392	567	685	51	72	257
	800	206	9.5	6,600	27,900	670,000	2,840,000	29492	608	765	74	100	272
480	650	103	5	2,400	12,000	245,000	1,220,000	29296	556	635	33	55	259
	730	150	6	4,200	18,700	430,000	1,910,000	29396	590	705	51	72	270
	850	224	9.5	7,500	31,500	765,000	3,200,000	29496	638	810	81	108	280
500	670	103	5	2,540	13,000	259,000	1,330,000	292/500	574	654	33	55	268
	750	150	6	4,300	19,300	435,000	1,970,000	293/500	611	725	51	74	280
	870	224	9.5	7,850	33,000	805,000	3,350,000	294/500	661	830	81	107	290
530	710	109	5	2,720	14,000	278,000	1,430,000	292/530	610	692	39	55	288
	800	160	7.5	5,000	23,300	510,000	2,380,000	293/530	648	772	54	76	295
	920	236	9.5	8,650	36,000	880,000	3,700,000	294/530	697	880	86	115	308
560	750	115	5	3,200	16,600	325,000	1,700,000	292/560	642	732	38	61	302
	980	250	12	9,300	40,500	945,000	4,100,000	294/560	743	938	90	121	321
600	800	122	5	3,500	18,300	355,000	1,870,000	292/600	686	780	40	63	321
	1,030	258	12	10,200	44,500	1,040,000	4,550,000	294/600	785	978	90	125	360
630	850	132	6	4,300	22,800	435,000	2,330,000	292/630	717	822	44	70	338
	1,090	280	12	11,600	51,000	1,180,000	5,200,000	294/630	830	1,040	100	136	365
670	1,150	290	15	12,900	57,000	1,320,000	5,850,000	294/670	880	1,105	106	138	387
710	1,060	212	9.5	8,350	40,500	850,000	4,150,000	293/710	850	1,030	76	102	393
	1,220	308	15	14,100	63,500	1,440,000	6,450,000	294/710	925	1,165	112	150	415
750	1,280	315	15	15,700	69,000	1,600,000	7,000,000	294/750	983	1,220	116	152	436
800	1,360	335	15	17,000	79,000	1,730,000	8,050,000	294/800	1,040	1,300	120	162	462

① Smallest allowable dimension for chamfer dimension r.

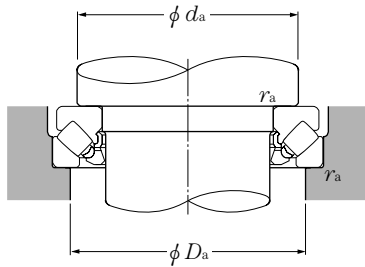

**Equivalent bearing load**

**dynamic**

$$P_a = F_a + 1.2F_r$$

**static**

$$P_{oa} = F_a + 2.7F_r$$

when  $\frac{F_r}{F_a} \leq 0.55$

Abutment and fillet dimensions			Mass
mm			kg
$d_a$	$D_a$	$r_{as}$	
min	max	max	(approx.)
490	525	4	76.6
525	575	5	172
560	630	6	333
<hr/>			
510	545	4	79.6
550	600	5	195
595	670	8	428
<hr/>			
530	570	4	82.8
575	630	5	221
615	690	8	443
<hr/>			
555	595	4	98.6
595	650	5	228
645	730	8	552
<hr/>			
575	615	4	102
615	670	5	235
670	750	8	569
<hr/>			
610	650	4	122
655	710	6	288
715	790	8	669
<hr/>			
640	690	4	144
755	835	10	815
<hr/>			
690	735	4	171
800	885	10	897
<hr/>			
725	780	5	213
845	935	10	1,110
<hr/>			
895	990	12	1,280
<hr/>			
870	930	8	669
950	1,050	12	1,520
<hr/>			
995	1,105	12	1,690
<hr/>			
1,060	1,175	12	2,040

